

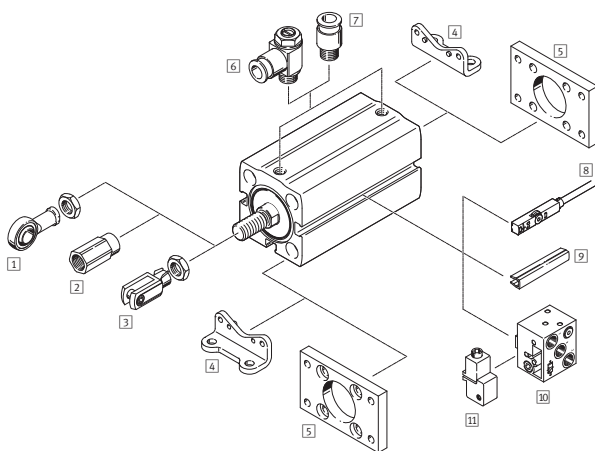

## Quickly available Compact cylinder ADN-S – Selected Products



- 1 Rod eye SGS/CRSGS  
→ page 4
- 2 Adapter AD → page 4
- 3 Rod clevis SG/CRSG  
→ page 4
- 4 Foot mounting HNA  
→ page 4
- 5 Flange mounting FNC  
→ page 4
- 6 One-way flow control valve  
GRLA/GRLZ → page 4
- 7 Push-in fitting QS → [qs](#)
- 8 Proximity sensor  
SME/SMT-10 → page 4  
SMT-8M/CRSMT-8M/  
SDBT-MS → page 5  
Position transmitter  
SDAS-MHS/SDAT-MHS/  
SMAT-8M → page 5  
Connecting cable NEBU  
→ page 4
- 9 Slot cover ABP-5 → page 5
- 10 Proximity sensor SMPO-8E  
→ page 5
- 11 Mounting kit SMB-8E  
→ page 5



Festo core product range  
Covers 80% of your automation tasks

Worldwide: Always in stock  
Superb: Festo quality at an attractive price  
Easy: Simplified procurement and warehousing  
Fast: Usually ready for dispatch within 24 hours ex works

Check our electronic catalogue for components and solutions that go beyond our core tasks and functions.

→ [www.festo.com/xdki](http://www.festo.com/xdki)

Or simply contact your Festo sales engineer. They'll be happy to help!

## Order code

001	002	003	004	005	006	007	008
ADN	S						

Legend:  Mandatory entry  Optional entry

001	Type
ADN	Compact cylinder, double acting
002	Design
S	Space optimized
003	Piston Ø [mm]
...	6, 10, 12, 16, 20, 25, 32, 40, 50, 63
004	Stroke [mm]
...	5, 10, 15, 20, 25, 30, 35, 40, 45, 50

005	Piston rod thread
A	Male thread
I	Female thread
006	Cushioning
-	Without cushioning
P	Elastic cushioning rings/plates on both sides
007	Position sensing
-	Without position sensing
A	Via proximity sensor

### Configurable product

This product and all its product options can be ordered online via the configurator:



→ [www.festo.com/catalogue/...](http://www.festo.com/catalogue/...)

Enter the part number or the type.

Part no.	Type	Part no.	Type
8084018	ADN-S-12	8084712	ADN-S-32
8084709	ADN-S-16	8084713	ADN-S-40
8084710	ADN-S-20	8084714	ADN-S-50
8084711	ADN-S-25	8084715	ADN-S-63

## Ordering – small sizes (Ø 6 mm/10 mm)

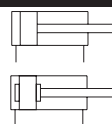
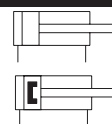
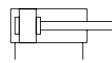
003 Piston Ø [mm]				ADN-S-6-...		ADN-S-10-...	
				004 Stroke [mm]		004 Stroke [mm]	
005	006	007	008	5	10	5	10
A	-	-	-	8080598	8080596	8080589	8080588
A	-	A	-	8080597	8080595	8080587	8080590
I	-	-	-	★ 4886885	★ 4886886	★ 4887523	★ 4887524
I	-	A	-	★ 5173732	★ 5173733	★ 5177082	★ 5177085

005 Piston rod thread	006 Cushioning	007 Position sensing
A: Male thread	-: Without	-: Without
I: Female thread	P: Elastic cush. rings	A: Via proximity sensor
A		
I		

## Ordering – Ø 12 mm/16 mm

003 Piston Ø [mm]				ADN-S-12-...						
				004 Stroke [mm]						
005	006	007	008	5	10	15	20	25	30	35
A	P	-	-	8091419	8091428	8091416	8091420	8091426	8091423	8091418
A	P	A	-	8091427	8091424	8091422	8091429	8091421	8091417	8091425
I	P	-	-	★ 8076407	★ 8076419	★ 8076417	★ 8076415	★ 8076413	★ 8076411	★ 8076409
I	P	A	-	8076406	8076418	8076416	8076414	8076412	8076410	8076408



003 Piston Ø [mm]				ADN-S-16-...						
				004 Stroke [mm]						
005	006	007	008	5	10	15	20	25	30	35
A	P	-	-	8091671	8091670	8091677	8091666	8091665	8091672	8091676
A	P	A	-	8091668	8091678	8091667	8091674	8091675	8091669	8091673
I	P	-	-	★ 8076393	★ 8076405	★ 8076403	★ 8076401	★ 8076399	★ 8076397	★ 8076395
I	P	A	-	8076392	8076404	8076402	8076400	8076398	8076396	8076394

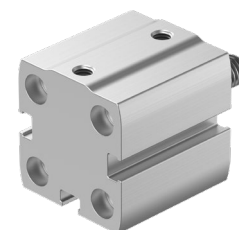

## Ordering – Ø 20 ... 63 mm

003 Piston Ø [mm]				ADN-S-20-...									
				004 Stroke [mm]									
005	006	007	008	5	10	15	20	25	30	35	40	45	50
A	P	–	–	8091431	8091449	8091447	8091445	8091443	8091441	8091439	8091437	8091435	8091433
A	P	A	–	8091430	8091448	8091446	8091444	8091442	8091440	8091438	8091436	8091434	8091432
I	P	–	–	★ 8076323	★ 8076341	★ 8076339	★ 8076337	★ 8076335	★ 8076333	★ 8076331	★ 8076329	★ 8076327	★ 8076325
I	P	A	–	8076322	8076340	8076338	8076336	8076334	8076332	8076330	8076328	8076326	8076324

003 Piston Ø [mm]				ADN-S-25-...									
				004 Stroke [mm]									
005	006	007	008	5	10	15	20	25	30	35	40	45	50
A	P	–	–	8092103	8092102	8092107	8092091	8092092	8092099	8092097	8092094	8092106	8092105
A	P	A	–	8092104	8092093	8092096	8092109	8092100	8092098	8092108	8092095	8092110	8092101
I	P	–	–	★ 8076343	★ 8076361	★ 8076359	★ 8076357	★ 8076355	★ 8076353	★ 8076351	★ 8076349	★ 8076347	★ 8076345
I	P	A	–	8076342	8076360	8076358	8076356	8076354	8076352	8076350	8076348	8076346	8076344

003 Piston Ø [mm]				ADN-S-32-...									
				004 Stroke [mm]									
005	006	007	008	5	10	15	20	25	30	35	40	45	50
A	P	–	–	8091452	8091461	8091460	8091453	8091467	8091465	8091456	8091450	8091451	8091462
A	P	A	–	8091464	8091457	8091469	8091468	8091459	8091454	8091463	8091455	8091466	8091458
I	P	–	–	★ 8076364	★ 8076382	★ 8076380	★ 8076378	★ 8076376	★ 8076374	★ 8076372	★ 8076370	★ 8076368	★ 8076366
I	P	A	–	8076363	8076381	8076379	8076377	8076375	8076373	8076371	8076369	8076367	8076365

003 Piston Ø [mm]				ADN-S-40-...									
				004 Stroke [mm]									
005	006	007	008	5	10	15	20	25	30	35	40	45	50
A	P	A	–	8092050	8092067	8092053	8092064	8092056	8092061	8092051	8092059	8092065	8092054
I	P	–	–	5138596	5138597	5138598	5138599	5138600	5138601	5138602	5138603	5138604	5138605
I	P	A	–	5138606	5138607	5138608	5138609	5138610	5138611	5138612	5138613	5138614	5138615

003 Piston Ø [mm]				ADN-S-50-...									
				004 Stroke [mm]									
005	006	007	008	5	10	15	20	25	30	35	40	45	50
A	P	A	–	8092081	8092073	8092085	8092076	8092075	8092074	8092071	8092087	8092079	8092086
I	P	–	–	5138178	5138179	5138180	5138181	5138182	5138183	5138184	5138185	5138186	5138187
I	P	A	–	5138188	5138189	5138190	5138191	5138192	5138193	5138194	5138195	5138196	5138197

003 Piston Ø [mm]				ADN-S-63-...									
				004 Stroke [mm]									
005	006	007	008	5	10	15	20	25	30	35	40	45	50
A	P	A	–	8092130	8092128	8092135	8092120	8092121	8092125	8092133	8092134	8092138	8092119
I	P	–	–	5132653	5132654	5132655	5132656	5132657	5132658	5132659	5132660	5132661	5132662
I	P	A	–	5132663	5132664	5132665	5132666	5132667	5132668	5132669	5132670	5132671	5132672

## Ordering – Accessories

		For piston Ø [mm]	12	16	20	25	32	40	50	63
1	Rod eye SGS			★ 9254	★ 9255	★ 9255	★ 9261	★ 9261	★ 9262	★ 9262
	Rod eye CRSGS			195580	195581	195581	195582	195582	195583	195583
2	Adapter AD			157328	157331	157332	157333	157334	160256	160257
				157329						
				157330						
3	Rod clevis SG			★ 3110	★ 3111	★ 3111	★ 6144	★ 6144	★ 6145	★ 6145
	Rod clevis CRSG			13567	13567	13568	13569	13569	13570	13570
4	Foot mounting HNA		537237	537238	537239	537240	537241	537242	537243	537244
5	Flange mounting FNC		537245	537246	537247	537248	★ 174376	★ 174377	★ 174378	★ 174379

**8** Connecting cable NEBU

Cable length [m]	Connection right	Part no.	Type
Connection left: straight socket, M8x1, 3-pin			
2.5	Cable, open end, 3-wire	★ 541333	NEBU-M8G3-K-2.5-LE3
5		★ 541334	NEBU-M8G3-K-5-LE3
Connection left: angled socket, M8x1, 3-pin			
2.5	Cable, open end, 3-wire	★ 541338	NEBU-M8W3-K-2.5-LE3
5		★ 541341	NEBU-M8W3-K-5-LE3

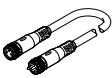

**6** One-way flow control valve GRLA, for exhaust air

For piston Ø [mm]	Pneumatic connection	Tubing O.D. [mm]	Part no.	Type
Slotted head screw				
12, 16, 20, 25	M5	3	★ 193137	GRLA-M5-QS-3-D
		4	★ 193138	GRLA-M5-QS-4-D
		6	★ 193139	GRLA-M5-QS-6-D
32, 40, 50, 63	G1/8	3	★ 193142	GRLA-1/8-QS-3-D
		4	★ 193143	GRLA-1/8-QS-4-D
		6	★ 193144	GRLA-1/8-QS-6-D
		8	★ 193145	GRLA-1/8-QS-8-D



**6** One-way flow control valve GRLZ, for supply air

For piston Ø [mm]	Pneumatic connection	Tubing O.D. [mm]	Part no.	Type
Slotted head screw				
12, 16, 20, 25	M5	3	★ 193153	GRLZ-M5-QS-3-D
		4	★ 193154	GRLZ-M5-QS-4-D
		6	★ 193155	GRLZ-M5-QS-6-D
32, 40, 50, 63	G1/8	3	★ 193156	GRLZ-1/8-QS-3-D
		4	★ 193157	GRLZ-1/8-QS-4-D
		6	★ 193158	GRLZ-1/8-QS-6-D
		8	★ 193159	GRLZ-1/8-QS-8-D



### Proximity sensor for piston Ø 6 ... 10 mm

**8** Proximity sensor, for C-slot, magneto-resistive SMT-10M

Description	Part no.	Type
N/O contact, inserted in the slot from above, flush with the cylinder profile		
PNP		
Plug M8x1, 3-pin, 0.3 m	★ 551375	SMT-10M-PS-24V-E-0.3-L-M8D
Cable, 3-wire, 2.5 m	★ 551373	SMT-10M-PS-24V-E-2.5-L-OE
NPN		
Plug M8x1, 3-pin, 0.3 m	★ 551379	SMT-10M-NS-24V-E-0.3-L-M8D
Cable, 3-wire, 2.5 m	★ 551377	SMT-10M-NS-24V-E-2.5-L-OE



**8** Proximity sensor, for C-slot, magneto-resistive SMT-10G

Description	Part no.	Type
N/O contact, insertable in the slot lengthwise		
PNP		
Cable, 3-wire, 2.5 m	547862	SMT-10G-PS-24V-E-2.5Q-OE
Plug M8x1, 3-pin, 0.3 m	547863	SMT-10G-PS-24V-E-0.3Q-M8D
NPN		
Cable, 3-wire, 2.5 m	8065030	SMT-10G-NS-24V-E-2.5Q-OE
Plug M8x1, 3-pin, 0.3 m	8065029	SMT-10G-NS-24V-E-0.3Q-M8D



**8** Proximity sensor, for C-slot, magnetic reed SME-10M

Description	Part no.	Type
N/O contact, inserted in the slot from above, flush with the cylinder profile		
Contacting, bipolar		
Plug M8x1, 3-pin, 0.3 m	★ 551367	SME-10M-DS-24V-E-0.3-L-M8D
Cable, 3-wire, 2.5 m	★ 551365	SME-10M-DS-24V-E-2.5-L-OE
Cable, 2-wire, 2.5 m	★ 551369	SME-10M-ZS-24V-E-2.5-L-OE







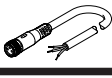

**8** Connecting cable NEBU

Cable length [m]	Connection right	Part no.	Type
Connection left: straight socket, M8x1, 3-pin			
2.5	Cable, open end, 3-wire	★ 541333	NEBU-M8G3-K-2.5-LE3
5		★ 541334	NEBU-M8G3-K-5-LE3
Connection left: angled socket, M8x1, 3-pin			
2.5	Cable, open end, 3-wire	★ 541338	NEBU-M8W3-K-2.5-LE3
5		★ 541341	NEBU-M8W3-K-5-LE3





## Ordering – Accessories

### Proximity sensor for piston $\varnothing$ 12 ... 63 mm

8 Proximity sensor, short version, for T-slot, magneto-resistive SMT-8M 		
Description	Part no.	Type
N/O contact, inserted in the slot from above, flush with the cylinder profile		
PNP		
Cable, 3-wire, 2.5 m	 574335	SMT-8M-A-PS-24V-E-2,5-OE
Plug M8x1, 3-pin, 0.3 m	 574334	SMT-8M-A-PS-24V-E-0,3-M8D
NPN		
Cable, 3-wire, 2.5 m	 574338	SMT-8M-A-NS-24V-E-2,5-OE
Plug M8x1, 3-pin, 0.3 m	 574339	SMT-8M-A-NS-24V-E-0,3-M8D
N/O contact, inserted in the slot from above, flush with the cylinder profile		
PNP		
Cable, 3-wire, 7.5 m	 574340	SMT-8M-A-PO-24V-E-7,5-OE



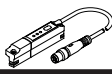

8 Proximity sensor, for T-slot, corrosion-resistant magneto-resistive CRSMT-8M 		
Description	Part no.	Type
N/O contact, inserted in the slot from above, flush with the cylinder profile		
PNP		
Cable, 3-wire, 5 m	574380	CRSMT-8M-PS-24V-K-5,0-OE
Plug M8x1, 3-pin, 0.3 m	574383	CRSMT-8M-PS-24V-K-0,3-M8D

8 Proximity sensor, for T-slot, to EU Explosion Protection Directive (ATEX), magneto-resistive SDBT-MS, 		
Description	Part no.	Type
N/O contact, inserted in the slot from above, secured with screw		
NAMUR		
Cable, 2-wire, 5 m	579071	SDBT-MS-20NL-ZN-E-5-LE-EX6
Cable, 2-wire, 10 m	579072	SDBT-MS-20NL-ZN-E-10-LE-EX6

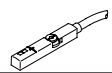
8 Position transmitter, for T-slot, magnetic Hall SDAS-MHS 		
Description	Part no.	Type
Inserted in the slot from above		
Cable with plug, M8x1, A-coded to EN 61076-2-104, 0.3 m	8063974	SDAS-MHS-M40-1L-PNLK-PN-E-0.3-M8
Cable, open end, 2.5 m	8063975	SDAS-MHS-M40-1L-PNLK-PN-E-2.5-LE

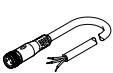
8 Position transmitter, for T-slot, magnetic Hall SDAT-MHS 		
Description	Part no.	Type
Inserted in the slot from above, secured with screw		
Plug M8x1, 4-pin, 0.3 m	1531265	SDAT-MHS-M50-1L-SA-E-0.3-M8

8 Position transmitter, for T-slot, magnetic SMAT-8M 		
Description	Part no.	Type
Insertable in slot, centre clamping		
Plug M8x1, 4-pin, rotatable thread, 0.3 m	553744	SMAT-8M-U-E-0,3-M8D

8 Connecting cable NEBU 			
Cable length [m]	Connection right	Part no.	Type
Connection left: straight socket, M8x1, 3-pin			
2.5	Cable, open end, 3-wire	 541333	NEBU-M8G3-K-2.5-LE3
5		 541334	NEBU-M8G3-K-5-LE3
Connection left: angled socket, M8x1, 3-pin			
2.5	Cable, open end, 3-wire	 541338	NEBU-M8W3-K-2.5-LE3
5		 541341	NEBU-M8W3-K-5-LE3

10 Proximity sensor, for T-slot, pneumatic SMPO-8E 		
Pneumatic connection	Part no.	Type
3/2-way valve, normally closed, inserted in the slot from above		
Female thread M5	178563	SMPO-8E

11 Mounting kit SMB-8E 		
Type of mounting	Part no.	Type
For proximity sensors SMPO-8E		
Clamped in T-slot	178230	SMB-8E

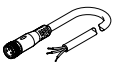
8 Connecting cable NEBU 			
Cable length [m]	Connection right	Part no.	Type
Connection left: straight socket, M8x1, 4-pin			
2.5	Cable, open end, 4-wire	541342	NEBU-M8G4-K-2.5-LE4
5		541343	NEBU-M8G4-K-5-LE4
Connection left: angled socket, M8x1, 4-pin			
2.5	Cable, open end, 4-wire	541344	NEBU-M8W4-K-2.5-LE4
5		541345	NEBU-M8W4-K-5-LE4

9 Slot cover, for T-slot ABP-5 		
Type of mounting	Part no.	Type
For sensor slots		
Length 2x 0.5 m	151680	ABP-5-S

## Worldwide always in stock: the Festo core product range for automation



**Festo core product range:** Festo quality at an attractive price, covering 80% of your automation tasks. From drives to accessories for factory automation as well as process automation – you can reduce procurement complexity for both the electric and pneumatic control chain.